



USER MANUAL

Thermal MSX[®]

Videoscope Kit

Kit no. VS290-32





USER MANUAL

Thermal MSX® Videoscope Kit

1 Advisories

1.1 Copyright

©2020 FLIR Systems, Inc. All rights reserved worldwide.

No parts of the software including source code may be reproduced, transmitted, transcribed or translated into any language or computer language in any form or by any means, electronic, magnetic, optical, manual or otherwise, without the prior written permission of FLIR Systems.

The documentation must not, in whole or part, be copied, photocopied, reproduced, translated or transmitted to any electronic medium or machine-readable form without prior consent, in writing, from FLIR Systems. Names and marks appearing on the products herein are either registered trademarks or trademarks of FLIR Systems and/or its subsidiaries. All other trademarks, trade names or company names referenced herein are used for identification only and are the property of their respective owners.

1.2 Quality Assurance

The Quality Management System under which these products are developed and manufactured has been certified in accordance with the ISO 9001 standard. FLIR Systems is committed to a policy of continuous development; therefore, we reserve the right to make changes and improvements on any of the products without prior notice.

1.3 Documentation

To access the latest manuals and notifications, go to the Download tab at: <https://support.flir.com>. It only takes a few minutes to register online. In the download area you will also find the latest releases of manuals for our other products, as well as manuals for our historical and obsolete products.

1.4 Disposal of Electronic Waste



As with most electronic products, this equipment must be disposed of in an environmentally friendly way, and in accordance with existing regulations for electronic waste. Please contact your FLIR Systems representative for more details.

2 Introduction

Thank you for selecting the VS290–32 kit. The kit includes the VS290–00 Videoscope Display and the VSC-IR32 Thermal MSX® Rectangular Probe.

The VS290 is the first industrial inspection Videoscope with Thermal, Visual, and MSX technology. The VS290 is a rugged, high quality, and reliable visual inspection instrument that improves productivity and reduces diagnostic time for facility diagnostics, utilities, manufacturing, public safety, and inspection service industries.

2.1 Product Features

- 160 x 120 IR imaging resolution with MSX® (Multi-Spectral Dynamic Imaging).
- Side-view probe (2 m) with flexible points and low-profile, rectangular camera tip.
- 14°F to 752°F (-10°C to 400 °C) temperature range.
- 57° x 44° field of view (FOV)
- Automatic hot/cold spotting and Isotherm (color) alarms.
- Text annotations (TCF).
- CAT IV 600 V safety rating.
- IP67 rated camera tip (IP54 rated base unit and probe).
- LED worklight.
- Longer than five (5) hours of battery operation on one charge.

2.2 Supplied Items and Accessories

The VS290–32 KIT includes the following:

- Videoscope display
- Thermal MSX camera and probe tube with flexible points
- Li ion rechargeable batteries (2)
- Battery charger (two bays)
- AC power supply
- USB-C cable
- SD card
- Software: License card for 'FLIR Thermal Studio Standard', 1 Year Subscription
- Wrist strap
- Hard-shell carry-case for all items
- Printed Quick Start and Warranty documentation

2.3 2–10 EXTENDED WARRANTY

To activate the extended 2–10 warranty, please register your product within 60 days of purchase. Otherwise, the standard one-year warranty will be in effect from date of purchase. The 2–10 warranty covers parts and labour for the camera for 2 years and coverage of the detector for 10 years. Register your product at <https://support.flir.com/prodreg>.

3 Safety

3.1 Safety Notes

- Before operating the device, you must read, understand, and follow all instructions, dangers, warnings, cautions, and notes.
- FLIR Systems reserves the right to discontinue models, parts or accessories, and other items, or to change specifications at any time without prior notice.
- This product conforms to UL STD 61010-1 and is certified to CSA STD C22.2, no. 61010-1.

 WARNING
<ul style="list-style-type: none">• Do not operate the device if you do not have the correct knowledge. Incorrect operation of the device can cause damage and injury to persons.• Do not use the device if it show signs of damage. Injury to persons can occur.• Be careful working near voltages > 25 V AC or 35 V DC. There is a risk of shock from these voltages. Injury to persons can occur.

 CAUTION
<p>Battery Safety</p> <p>Do not incinerate or disassemble batteries. Batteries can explode or otherwise release toxic materials.</p> <p>Do not short circuit batteries, this may cause burns.</p> <p>Attention. Ne pas incinérer ni démonter les piles. Les batteries peuvent exploser ou libérer des matières toxiques.</p> <p>Ne court-circuitez pas les piles, cela pourrait provoquer des brûlures.</p>

**WARNING****FCC Warnings. Applicability: Class B digital devices.**

This equipment has been tested and found to comply with the limits for a Class B digital device, pursuant to Part 15 of the FCC Rules. These limits are designed to provide reasonable protection against harmful interference in a residential installation. This equipment generates, uses and can radiate radio frequency energy and, if not installed and used in accordance with the instructions, may cause harmful interference to radio communications. However, there is no guarantee that interference will not occur in a particular installation. If this equipment does cause harmful interference to radio or television reception, which can be determined by turning the equipment off and on, the user is encouraged to try to correct the interference by one or more of the following measures:

- Reorient or relocate the receiving antenna.
- Increase the separation between the equipment and receiver.
- Connect the equipment into an outlet on a circuit different from that to which the receiver is connected.
- Consult the dealer or an experienced Radio / TV technician for help.

Unlicensed band: This device complies with Part 15 of the FCC Rules. Operation is subject to the following two conditions: (1) this device may not cause harmful interference, and (2) this device must accept any interference received, including interference that may be caused by unintended operation.

(15.21): Changes or modifications to this unit not expressly approved by the party responsible for compliance could void the user authority to operate the equipment.

**CAUTION**

- Do not point the infrared camera at strong energy sources, such as the sun, as this can have an undesirable effect on the camera accuracy and can cause camera damage.
- Use caution when cleaning the camera lens as the lens has a protective coating that is easily damaged.
- Do not use excessive force when cleaning the camera lens. Damage to the protective lens coating can occur.

NOTE

The encapsulation rating is only applicable when all the openings on the camera are sealed with their correct covers, hatches, or caps. This includes the compartments for data storage, batteries, and connectors.

4 Product Description

4.1 Videoscope Base Unit Description

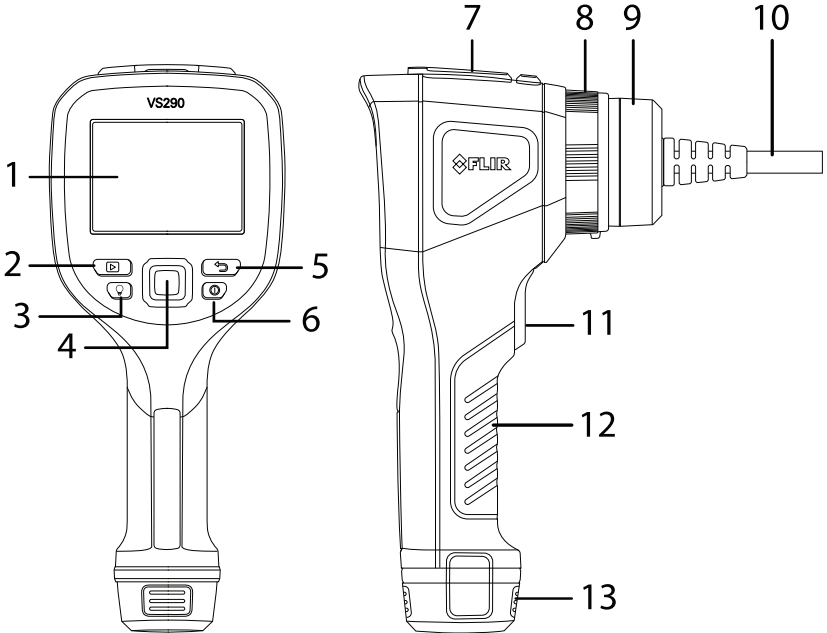

Figure 4.1 Base Unit Description

1. Camera display
2. Image and video Gallery button
3. LED worklight button
4. Navigation Pad. Menu button (centre) and navigation buttons (outer ring)
5. Return button (exit a menu)
6. Power button (long press)
7. USB connector and memory card compartment
8. Collar screw locks probe to VS290
9. Probe connector
10. Probe tube
11. Image and video capture trigger
12. Handle grip
13. Battery in battery compartment

4.2 Control Buttons

The four control buttons and navigation pad are explained below.

4.2.1 Power Button



Long press the power button to switch the instrument ON or OFF.

4.2.2 Return Button



Press the Return button to exit or move backward in the programming menu.

4.2.3 Gallery Button



Press the Gallery button to access the stored images and video. Press the Return button  to exit the gallery.

4.2.4 Worklight Button



Press the Worklight button to switch the probe tip light ON or OFF.

4.2.5 Navigation Pad

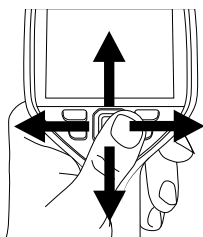

Figure 4.2 Navigation Pad. Menu button (centre) and outer navigation buttons (left/right, up/down).

Press the centre button to open the main menu and use it in the menus to make selections. Use the outer navigation buttons to move up/down and left/right in the program menus.

4.3 Top Compartment

Open the top flap to access the USB connector and the SD card slot.

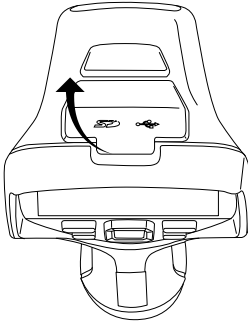

Figure 4.3 Accessing the USB connector and SD card in the top compartment.

4.4 Rectangular Probe (VSC-IR32)

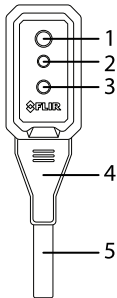

Figure 4.4 Camera lenses and worklight.

1. Thermal camera lens
2. Digital camera lens
3. LED worklight
4. Connector: Probe tube to probe tip
5. Probe tube

4.5 Display Description

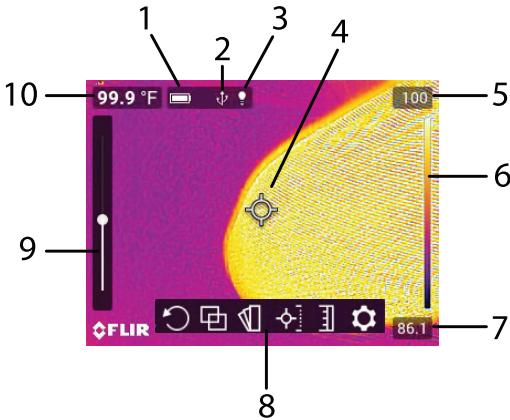

Figure 4.5 Videoscope display.

1. Battery status
2. USB active
3. Worklight active
4. Cross-hairs. Target a surface spot to measure its temperature. See Section 7.6, *Measurements Menu*, for additional cross-hairs functionality.
5. Highest temperature sensed in the current camera image.
6. Range of the selected display color palette. In the Above/Below Alarm Color modes, alarm alerts are represented here.
7. Lowest temperature sensed in the current camera image.
8. Main menu icons.
9. Thermal MSX alignment sliders. Vertical and horizontal sliders are used to align the super imposed thermal and digital camera images. The horizontal slider is obstructed in the image above.
10. Temperature reading of targeted spot. In Hot/Cold Spot modes, this area will show the MAX or MIN temperature (see Section 7.6, *Measurements Menu*, for more).

5 Battery Charging and Use

The VS290–32 kit is supplied with two high capacity batteries and a stand-alone two-bay charger. To charge batteries, place them in the charger and plug the charger into an AC receptacle. The LED indicators on the charger flash while a battery is charging and glow steadily when fully charged. It may require up to 2 hours for a full charge if a battery is completely drained.

You can also charge a battery while it is in the camera by connecting the VS290 directly to an AC wall charger (5V / 2A) using the supplied USB cable. The USB connector is located in the VS290 top compartment. See illustration below.

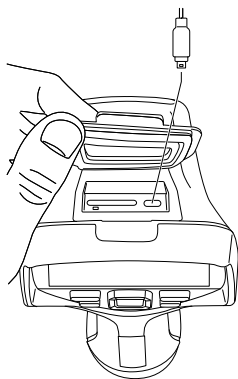



Figure 5.1 Charging a battery while it is installed in the instrument.

Once charged, place a charged battery into the battery compartment and long press the power button  to power the instrument. If an error message appears informing that the battery voltage is low, charge the battery immediately.

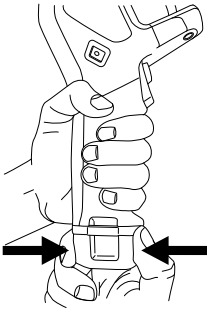

Figure 5.2 Installing and removing a battery.

6 Quick Steps

These steps are provided to provide a simple overview. Please read the entire User Manual before putting these devices into professional operation.

1. Insert a fully charged battery into the VS290 handle.
2. Long press the power button  to power up.
3. When powered, the VS290 displays a camera image and several function indicators, dependant on the configuration of the instrument.



Figure 6.1 Viewing a camera image.



4. Carefully position the probe into the area to be examined and view the camera image on the display. Short press the worklight button  to switch the light on/off.



Figure 6.2 Insert the probe into the test area.

5. To select an image mode, press the Menu button (centre), scroll to the Image Mode icon and press Menu again. Use the navigation buttons to select Thermal MSX, Thermal, or Digital camera; press Menu to confirm.
6. The cross-hairs allow you to target and measure the surface temperature of a spot. The measurement is shown digitally (upper left). The thermal scale for the current image is shown on the right edge of the display.
7. To capture an image or to stop/start a video, pull and hold the trigger. Press the Gallery button  to view stored images and videos. Images/videos can be transported to a PC via USB.

7 Programming Menus

7.1 Basic Navigation

Press the Menu button (centre) to open the main menu and the sub-menus. Use the navigation buttons to scroll left/right and up/down. Use the Menu button (centre) to confirm a selection; press the Return button ↵ to exit a menu.

7.2 Main Menu



The main menu options are: 1. Image Rotation, 2. Image Mode, 3. Color, 4. Measurement, 5. Temperature Scale, and 6. Settings.

7.3 Image Rotation Menu

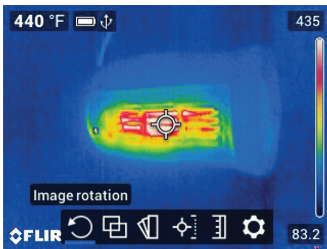

Figure 7.1 Accessing the Image Rotation mode.

Press Menu on the Image Rotation icon and use the navigation buttons to select 90° rotation or horizontal/vertical flip of the camera image. Press Menu to confirm.

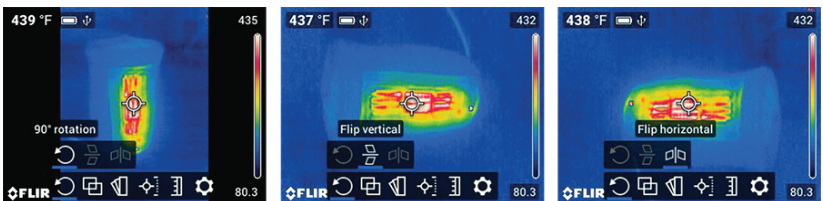

Figure 7.2 Selecting 90° Rotation or Vertical/Horizontal Flip.

7.4 Image Mode Menu

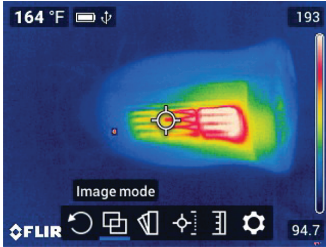



Figure 7.3 Accessing the Image Mode menu.

 Press Menu on the Image Mode icon and use the navigation buttons to select: Digital, Thermal, Thermal MSX, or Alignment Distance.

Thermal MSX (Multi-Spectral Dynamic Imaging) is an enhancement that improves image clarity by embossing visual scene details on the thermal image, providing added context to accurately target potential issues. The MSX Alignment Distance option allows you to fine tune the embossed visual scene details using the vertical and horizontal sliders. See Figure 7.5 below.

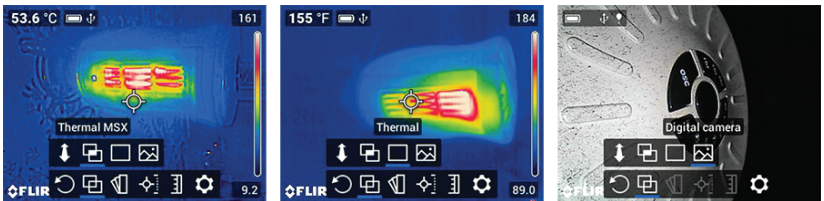

Figure 7.4 Selecting the Thermal MSX, Thermal only, and Digital Camera modes.



Figure 7.5 Select the Thermal MSX mode and then the Alignment Distance option. Use the sliders (left side and bottom of the display) to align the Digital Camera image with the Thermal image. Use the left/right and up/down arrow buttons to make the adjustments.

7.5 Color Palette Menu

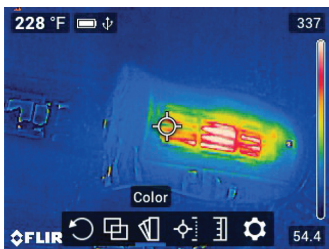

Figure 7.6 Accessing the Color Palette mode.

To select a display color palette, press Menu on the Color icon and use the navigation arrows to scroll. Press Menu when the desired color palette is selected (Iron, Rainbow, Gray, Above Alarm, or Below Alarm).

In the Above/Below Alarm modes (known as ‘Isotherms’), you select a high alarm set point (for Above Alarm mode) and a low alarm set point (for Below Alarm mode). The colorations in the thermal image indicate the sections of the test area that exceed the set point limit. Use the arrow buttons to set the temperature limits (the set point is shown on the bottom of the display). The vertical color bar graph on the right side of the display indicates the degree to which the alarm set point is exceeded. See Section 9, *Isothermal Color Alarms*, for more.



Figure 7.7 Selecting a Color palette or an Isotherm Alarm (Above and Below) mode.

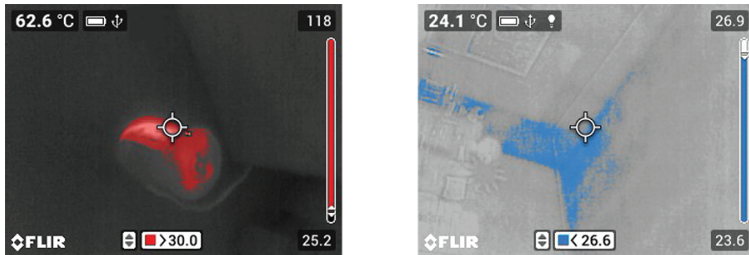

Figure 7.8 Isotherm Alarm examples.

7.6 Measurements Menu

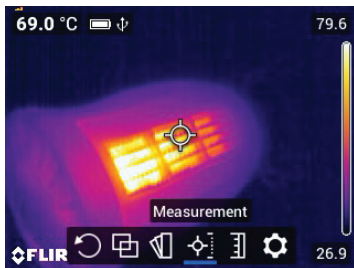







Figure 7.9 Accessing the Measurements mode menu.

 Navigate to the Measurement icon and press Menu. Select from the available options, detailed below, and then press Menu to confirm.

- Centre Spot . Position the camera to target a surface spot with the cross-hairs to measure its temperature. The temperature measurement is shown in the upper left corner of the display (digitally).
- Hot Spot . Position the camera so that the rectangle display target is covering an area of interest. The cross-hairs will move to the hottest (MAX) spot automatically (inside the rectangle target). The MAX temperature is shown, digitally, in the upper left corner.
- Cold Spot . Position the camera so that the rectangle display target is covering an area of interest. The cross-hairs will move to the coldest (MIN) spot automatically (inside the rectangle target). The MIN temperature is shown, digitally, in the upper left corner.
- No Measurements. 

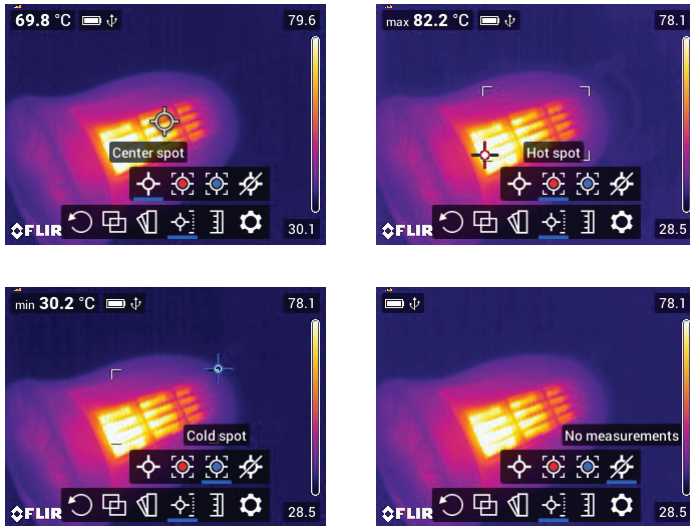

Figure 7.10 Select a measurement type. Centre Spot for manual targeting (temperature displayed on upper left corner of display); Hot Spot for automatic targeting of hottest spot in the target rectangle; Cold Spot for automatically targeting coldest spot in the rectangle; No Measurements for removing the temperature display digits.

7.7 Temperature Scale Menu

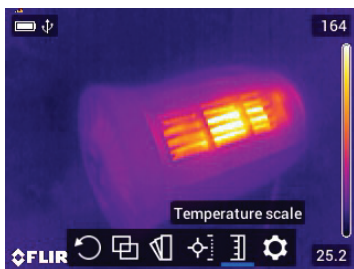



Figure 7.11 Accessing the Temperature Scale menu.

 Navigate to the Temperature Scale icon and press Menu. Use the navigation buttons to select Auto (where the camera uses the entire thermal range), or Lock (where you can freeze the range to a narrow thermal region).

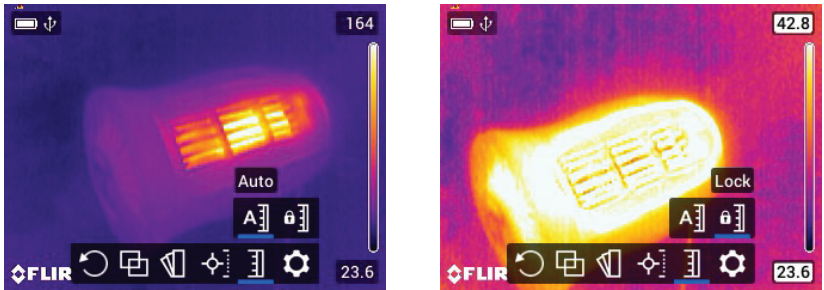

Figure 7.12 Image on left shows Auto mode where the temperature range uses all of the available spectrum. Image on right shows the Lock mode where the temperature range can be constrained. To constrain the range, point to a spot in the frame that represents the temperature of interest, and then select the Lock mode.

7.8 Settings Menu Overview



The settings menu has four sub-menus: Recording mode, Measurement parameters, Save options, and Device settings. See below.

7.9 SETTINGS MENU

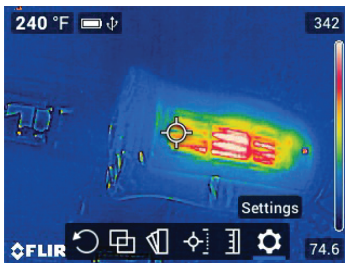

Figure 7.13 Accessing the Settings menu.

7.9.1 Recording Mode Sub-Menu

Press Menu on the Settings icon and press Menu again at the Recording Mode sub-menu. Select Video or Single-shot using the navigation buttons and press Menu to confirm. Pull and hold the trigger to start/stop a video recording or to capture a single image.

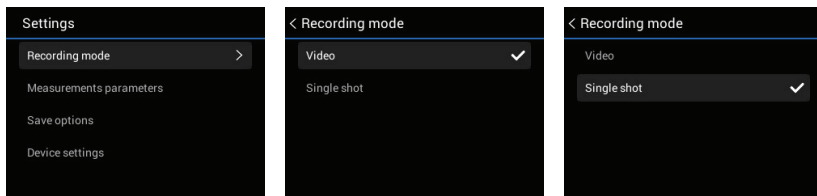

Figure 7.14 Select Video or Single shot (still image) mode. When the trigger is pulled, a video or a photo will be stored, depending on the selection made here.

7.9.2 Measurement Parameters Sub-Menu

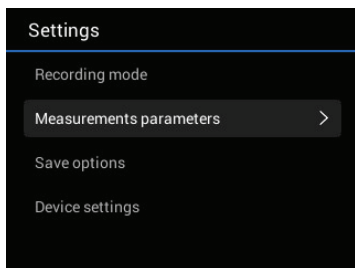

Figure 7.15 Accessing the Measurement Parameters menu.

Press Menu on the Settings icon and press Menu again at the Measurement Parameters sub-menu. Perform one or more of the steps below:

- Scroll to the Emissivity option and press Menu. Select a preset or choose a custom emissivity setting.

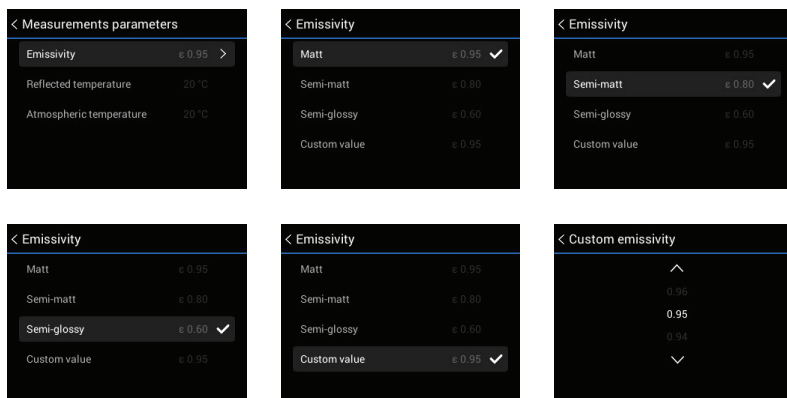

Figure 7.16 Selecting an emissivity preset or a customer setting.

- Scroll to the Reflected Temperature option, press Menu, and set a reflected temperature value.

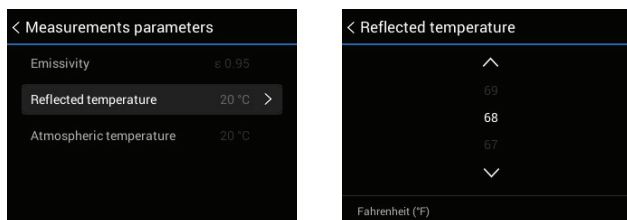

Figure 7.17 Setting the Reflected Temperature value using the up/down arrow buttons.

- Scroll to the Atmospheric Temperature option, press Menu, and set an atmospheric temperature value.

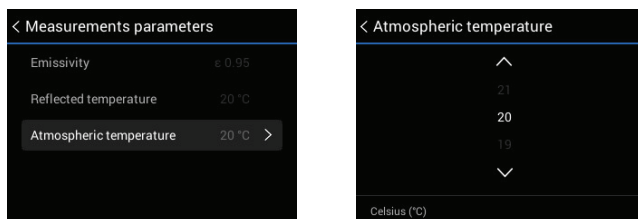

Figure 7.18 Selecting the Atmospheric Temperature using the up/down arrow buttons.

7.9.3 Save Options Sub-Menu

Press Menu on the Settings icon and press Menu again at the Save Options sub-menu. When set to ON, the camera stores two images (thermal and digital) for each Thermal MSX image captured. Use the navigation buttons to set on/off and press Menu to confirm.

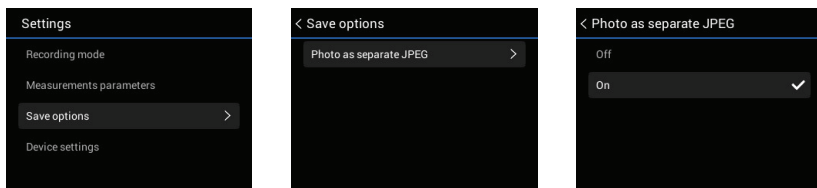

Figure 7.19 Determine if you'll need a separate digital camera image along with each thermal image captured.

7.9.4 Device Settings Sub-Menu

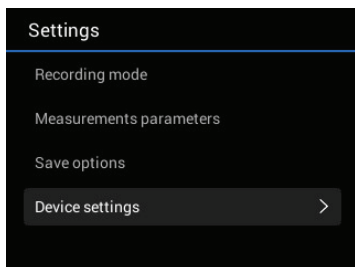

Figure 7.20 Accessing the Device Settings sub-menu.

Press Menu on the Settings icon and press Menu again at the Device Settings sub-menu to begin programming or viewing the following items. Each menu is explained in detail below.

- Set the Language, Time/Date, and Units of measure.

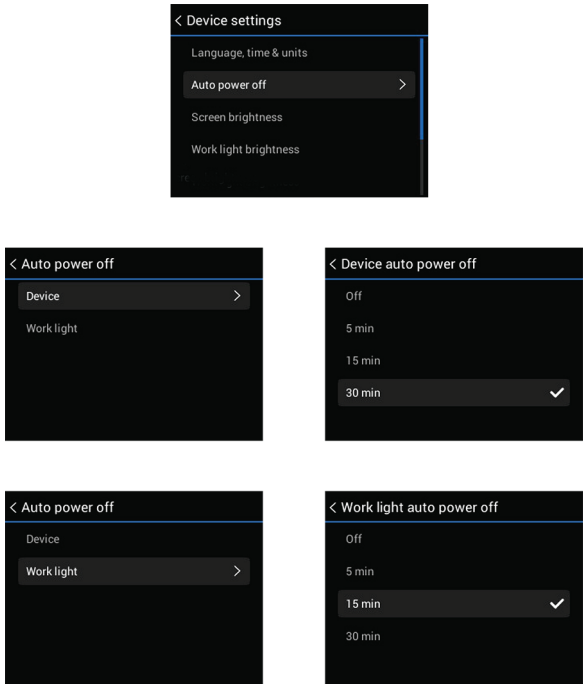

Figure 7.21 Selecting the user interface Language.

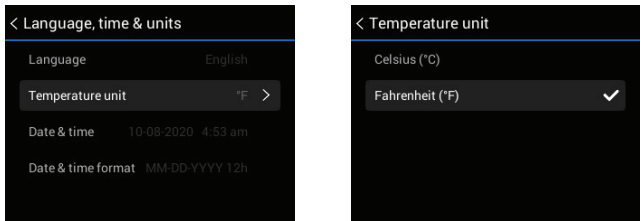

Figure 7.22 Selecting the Temperature Units.

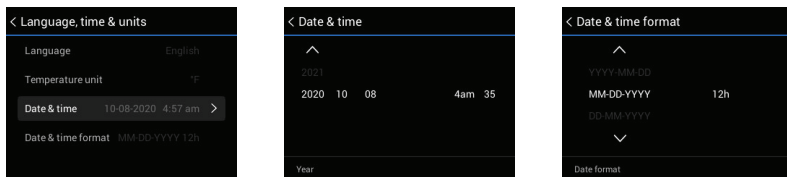

Figure 7.23 Setting the Date, Time, and Format.

- Set individual Auto Power Off (APO) timers for the camera and the worklight.

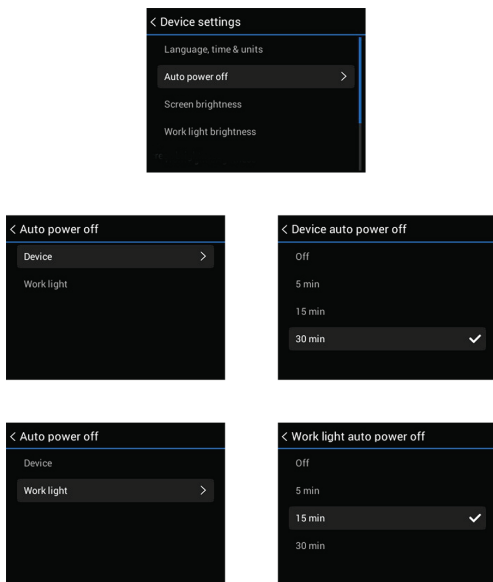

Figure 7.24 Setting the APO time for the main unit and the worklight.

- Adjust the screen and worklight brightness.

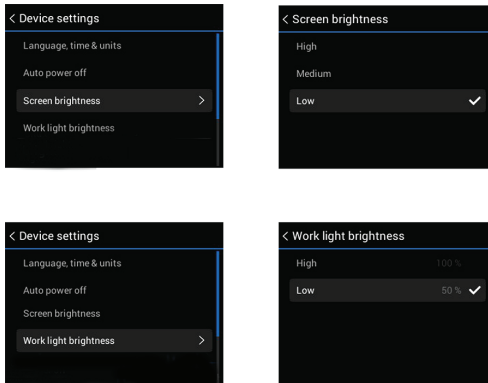

Figure 7.25 Set the display and worklight brightness.

- View system information including serial number and firmware version.

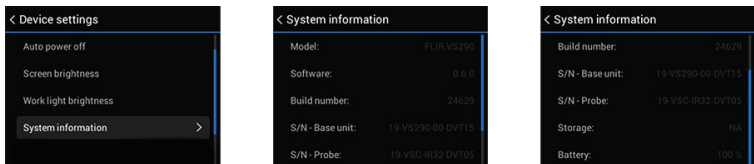

Figure 7.26 View the System Information.

- Revert to factory default conditions and format memory card.

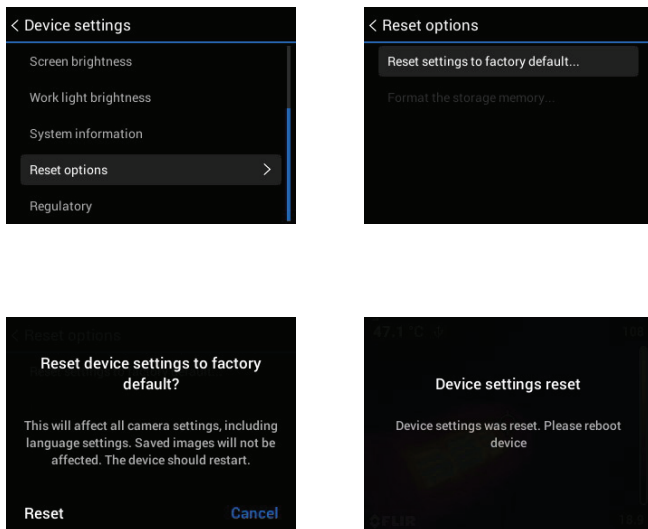

Figure 7.27 Reset the unit to factory default conditions.

- View regulatory data.

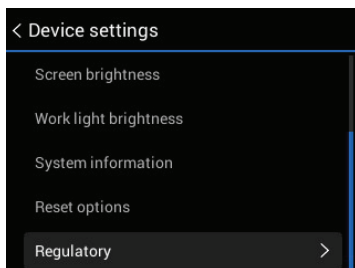

Figure 7.28 Accessing the Regulatory compliance information.

8 Taking Measurements

NOTE

Before proceeding to put the VS290 into professional operation ensure that all system, safety, and programming information is well understood as explained in this operation manual.

8.1 Charge and Install the Battery

As discussed in Section 5, *Battery Charging*, place the batteries in the supplied bay charger. Connect the charging bay to an AC source to begin charging.

Once charged, insert a battery into the VS290 and long press the power button  to power up the instrument.

8.2 Power-up Display Configuration

When you power up the VS290, the display will show the camera image for the currently selected Image Mode (Thermal MSX, Thermal, or Digital camera). The digits and icons that are displayed also depend on the configuration of the camera. See Section 4.5, *Display Description*, for details.

8.3 Programming the Instrument

Before taking measurements you'll want to configure the instrument to best match the application at hand. See the following parameter list for the most commonly used options. Refer to Section 7, *Programming Menus*, for complete instructions on these and other options.

- Image Mode (Thermal MSX, Thermal-only Camera, or Digital Camera).
- Thermal display color palette.
- Measurement Mode (Color spot, Hot spot, Cold spot, or No Measurements).
- Emissivity.
- User interface Language.
- Temperature units (°C / °F).
- Auto Power Off (APO) timer.
- Display and worklight brightness.

8.4 Positioning the Probe into the Test area

1. Carefully position the probe into the area to be examined, as shown in accompanying figure.





Figure 8.1 Inserting the probe into the test area.

2. View the image for the area you are inspecting.



Figure 8.2 View the test area on the VS290 display.

3. Short press the worklight button  to switch the light on/off if added illumination will help in your inspection work.
4. To select an image mode, press the Menu button (centre), scroll to the Image Mode icon and press Menu again. Use the navigation buttons to select Thermal MSX, Thermal, or Digital camera; press Menu to confirm.
5. The cross-hairs allow you to target and measure the temperature of a surface area. The measurement is shown digitally (upper left). The thermal scale for the current image is shown on the right edge of the display.

6. To capture an image or to stop/start a video, pull and hold the trigger. Press the Gallery button  to view stored images and videos. Images/videos can be transported to a PC via USB.

9 Isothermal Color (Above and Below) Alarms

9.1 Isotherms Overview

Isotherm Alarms allow you to set a high and/or low temperature set point. The image colorings show the areas that exceed the set point temperatures. To configure the Isotherms, open the Color menu and select the desired alarm mode. Use the navigation arrows to select the temperature set point. The hot alarm color code is red while the cold alarm color code is blue.

9.2 Isotherm Screen Shots

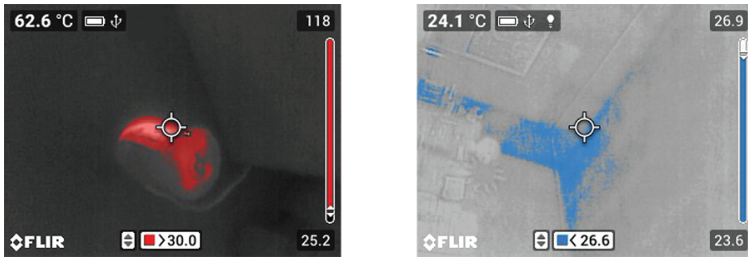

Figure 9.1 'Above Alarm' (left) shows a high temperature alarm setup. The alarm set point is shown on the bottom of the display (red), use the up/down arrows to adjust the set point. 'Below Alarm' (right) shows a low temperature alarm setup. The alarm set point is shown on the bottom of the display (blue), use the up/down arrows to adjust the set point.

10 Working with Images and Video

10.1 SD Card Slot

The SD Card slot is located inside the VS290 top compartment. See illustration below. Do not remove or insert an SD Card with the camera powered up. Do not use an SD Card that has been formatted by another camera as the file structure system may differ.

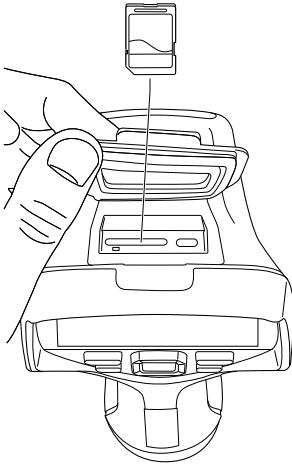

Figure 10.1 SD Card slot in top compartment.

10.2 Capturing Images and Video

First select image mode (single-shot) or Video mode by pressing Menu on the Settings icon and pressing Menu again at the Recording Mode sub-menu.

Select Video or Single-shot using the navigation buttons and press Menu to confirm.

Pull and hold the trigger to capture an image or to start recording video. For images, release the trigger when the filename appears. For video, release the trigger when the video timer starts. Pull and hold trigger to stop the video recording.

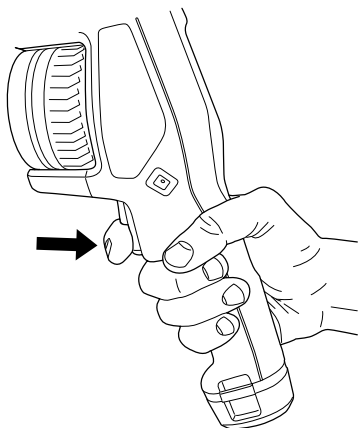



Figure 10.2 Pull and hold the trigger to capture an image or start a video.

Images and videos are stored on the memory card (supplied) inserted in the VS290 top compartment. Do not insert or remove the memory card while the VS290 is powered.

10.3 Viewing Images and Video

Press the Gallery button  to open the image/video gallery. Scroll to an image/video and press Menu to open it. Press Menu again at an opened image/video to access these options: Play (video only), full screen mode, image/video information, and image/video delete.

10.4 Transferring Images and Video

Transfer to a PC by first connecting the VS290 to a PC using the supplied USB cable (the USB connector is located in the VS290 top compartment), and then use the VS290 as you would a typical external storage drive.

You can also transfer images and videos directly from the SD card. With the camera power off, remove the SD card from the VS290 top compartment and insert it into a standard SD card reader. Follow the instructions provided by the SD card reader manufacturer.

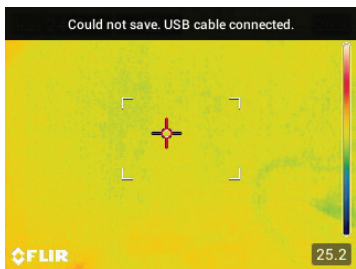
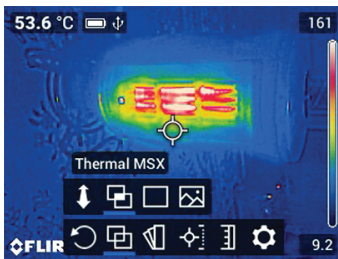

Figure 10.3 The VS290 must be disconnected from the PC, otherwise the error message shown will appear when you attempt to capture an image.

11 MSX® Imaging Technology

MSX (Multi-Spectral Dynamic Imaging) extracts scene details from the built-in visual camera and embosses them onto the full thermal image. This allows you to see the thermal image in context of the environment you are viewing. The added context assists in accurately targeting potential problems in electrical, mechanical, and building applications.

Press Menu on the Image Mode icon and use the navigation buttons to select Thermal MSX. See the menu in Section 7.4, *Image Mode*, for complete programming details.



Thermal MSX

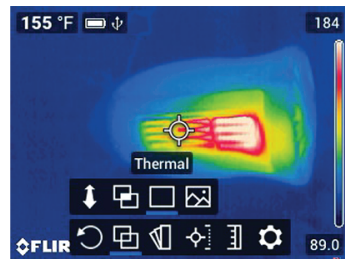

Thermal only

Figure 11.1 Thermal MSX image on left shows the detail from the digital camera image superimposed on the thermal image. Image on right shows the thermal only version.

12 Specifications

IMAGING AND OPTICAL SPECIFICATIONS	
IR Resolution	160 x 120 pixels
Digital image enhancement	Yes
Thermal sensitivity /NETD	< 100 mK
Field of View (FOV)	57° x 44°
Minimum focus distance	5.9 in. (0.15 m)
Image frequency	8.7 Hz
IMAGE PRESENTATION	
Display resolution	320 x 240 pixels
Screen size	3.5 in. (8.9 cm)
Color palettes	Iron, Rainbow, Gray, and Below/Above Alarms
Image modes	IR only, visual only, MSX
MEASUREMENT AND ANALYSIS	
Probe length	6.6 ft. (2 m)
Object temperature range	14°F to 752°F (-10°C to 400°C)
Measurement accuracy	At ambient temperature. 59 to 95°F (15 to 35°C) and object temp. above 32°F (0°C), 32 to 212°F (0 to 100°C): ±5.5°F (±3°C), 212 to 752°F (100 to 400°C): ±3%
Spotmeter	1 (in live mode)
Measurement presets	Centre / Hot / Cold Spot and No Measurement mode
Emissivity correction	3 presets and 1 custom setting
IMAGE STORAGE AND VISUAL (DIGITAL) CAMERA	
Storage capacity	Removable SD Card (16 GB)
Image/Video file formats	Image: Radiometric .jpg Video: .mpeg-4
Digital camera resolution	2 MP
Field of View (FOV)	83°
WORKLIGHT	

Worklight type	Bright LED
DATA COMMUNICATION	
USB	USB Type-C (data transfer/power)
ADDITIONAL DATA	
Battery type	Rechargeable 3.7 V Lithium ion
Battery operating time	> 5 hours (full display brightness and work-light ON)
Weight	Complete kit with case: 28.7 lbs. (13 kg) Display: 1.41 lbs. (640 g) Probe: 1.04 lbs. (470 g)
Size (L x W x H)	Complete kit with case: 47 x 18.9 x 7.9 in. (120 x 48 x 20 cm) Display: 10.4 x 4.3 x 4.3 in. (26.4 x 11 x 11 cm) Probe: 83.5 x 0.3 in. (212.2 x X 0.69 cm)
Safety Compliance	This product conforms to UL STD 61010-1 and is certified to CSA STD C22.2, no. 61010-1.
BOX CONTENTS	
Videoscope display, Thermal MSX camera probe, rechargeable batteries (2), battery charger, SD card, USB cable, wrist strap, hard case, printed documentation	

13 CUSTOMER SUPPORT

Customer Support Telephone List:	https://support.flir.com/contact
Repair, Calibration, and Technical Support	https://support.flir.com



Website

<http://www.flir.com>

Customer support

<http://support.flir.com>

Copyright

© 2020, FLIR Systems, Inc. All rights reserved worldwide.

Disclaimer

Specifications subject to change without further notice. Models and accessories subject to regional market considerations. License procedures may apply. Products described herein may be subject to US Export Regulations. Please refer to exportquestions@flir.com with any questions.

Publ. No.: NAS100060
Release: AA
Commit: 71942
Head: 71942
Language: en-US
Modified: 2020-11-16
Formatted: 2020-11-16