

**EASY-LASER®**

XT770

Download on the  
App Store

GET IT ON  
Google Play

RUN IT ON  
EASY-LASER **XT11**



Know your machine from every angle. **Shaft Alignment**

**XT770**

# MEASUREMENT INDEPENDENCE

## EASY-LASER® GENERATION XT

Easy-Laser® XT770 is the most powerful of our Generation XT shaft alignment systems. Built upon our groundbreaking cross-platform technology, it gives you the freedom to work with the display unit that suits you and the job best. Simply download our straightforward XT application for free and you have all the measurement programs you need.

## SAME INTERFACE

The XT app interface and basic functionality is identical for all levels of Generation XT systems. Easy to learn and use!

## NO LICENSE HASSLE

Your Generation XT measuring units determine what functions are available. No hassle with licenses, just connect the units to the app, on any of your display devices, and start measuring. That is straightforward!

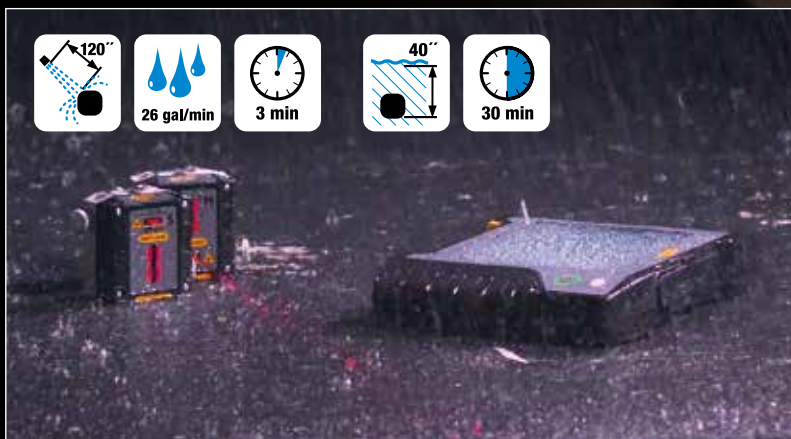

**IP66 and IP67 rated units**

*(Note: Photo shows XT40 measuring units.)*



# HIGHLIGHTS

## MAXIMUM FLEXIBILITY



### ALL XT PROGRAMS IN ONE FREE APP

All XT measurement programs included in one straightforward application available for free.



### DISPLAY DATA ON MULTIPLE PLATFORMS

Functionality for iOS, Android and Easy-Laser® XT display units.



### NO LOCK-INS

Buy with or without the new user-friendly Easy-Laser® display unit.



### MAXIMUM FLEXIBILITY

Combine several measuring units with the display unit of your choice, or use different display units with one set of measuring units. No license hassle!



### RUGGED DESIGN

The XT products are rugged, rated IP66 and IP67 water and dust proof. For superior durability in harsh environments.



### LONG OPERATING TIMES

The long operating times of up to 16 hours for the display unit and 24 hours for the measuring units mean even the toughest jobs will be finished on time with no interruptions.



### SEND THE REPORTS

Share the reports via email. Possible on all platforms.

# XT770

(Note: Photo shows XT60 measuring unit.)

# THIS IS EASY ALIGNMENT

## HORIZONTAL PROGRAM

The user interface is intuitive and guides you through the measurement process. You can save the measurements of a machine for *As found* and *As left* in the same file.



The interactive workflow indicator lets you easily jump to any part in the measurement process.

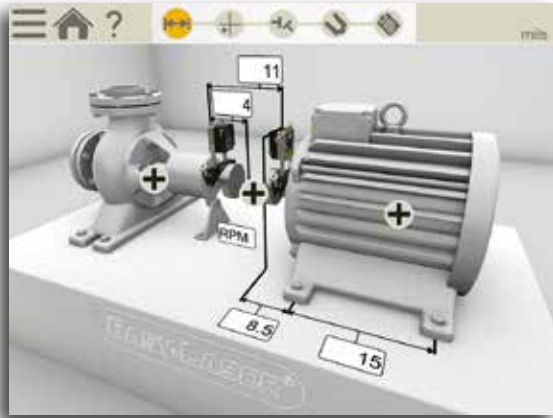
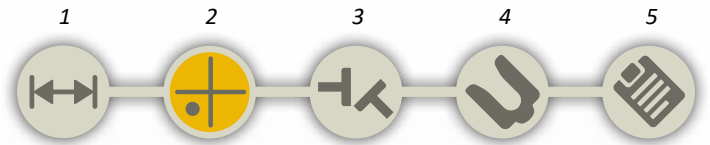

1. Enter dimensions



2. Measure

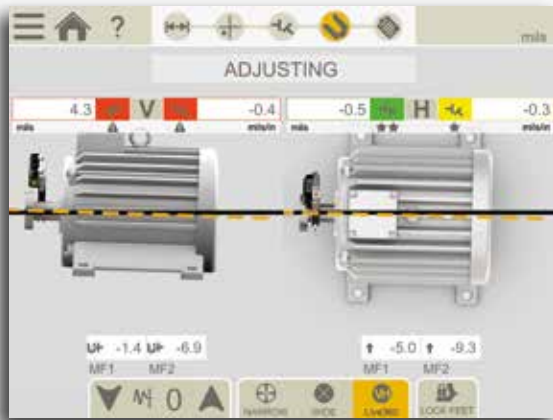

3. View result, *As found*

4. Adjust, *As left*



5. Documentation

(Send PDF report to USB or by WiFi)



Soft Foot check on both machines.



Tolerance check. Pre-set or custom.



Quality check view for measurements



# MEASUREMENT METHODS

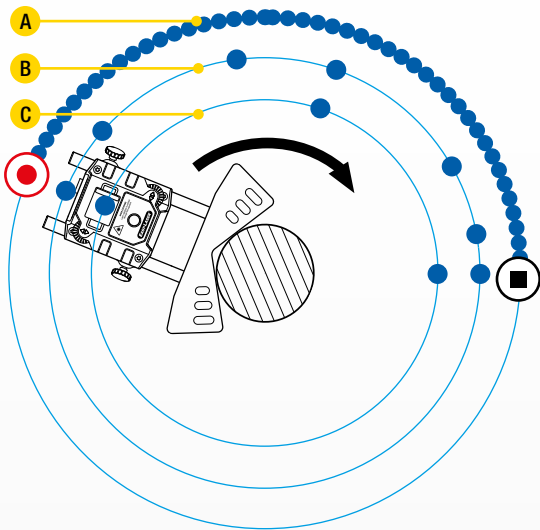

● Measuring points

● Start recording    ■ Stop recording



A

## CONTINUOUS SWEEP

Automatic recording of measurement values during continuous sweeping of the shafts. Hundreds of points are registered. You can start and stop anywhere on the turn.



B

## MULTIPOINT

Multipoint measurement lets you take readings at any rotational position. Great for uncoupled shafts, hard-to-turn shafts, and high vibration environments.



C

## EASYTURN

The EasyTurn™ function allows you to begin the measurement process from anywhere on the turn. You can turn the shaft to any three positions to register the measurement values.



## 9-12-3

Measurement points are recorded at fixed points 9, 12 and 3 o'clock. Useful for shafts oriented vertically or wall-mounted machines.

# SMART FUNCTIONS



## THERMAL GROWTH

Automatically compensate for thermal expansion of the machines.



## SWAP VIEW

Understand adjustment directions more intuitively.



## CONTINUE SESSION

Your latest measurement is always available, automatically saved.



## TEMPLATES

Save measurement files as templates, with machine data and settings, to quickly start measurements.



## MEASUREMENT VALUE FILTER

Improve readings when vibration or poor measuring conditions present a challenge.

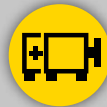

## MULTIPLE SETS OF FEET

Align machines with more than two pairs of feet.



## LOCK FEET

Lock any pair of feet on the machine. Helps with aligning base-bound or bolt-bound machines.



## WIDE LIVE ADJUSTMENT

Adjust with live values using expanded sensor position ranges in the H and V position.

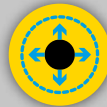

## 360° LIVE ADJUSTMENT

Adjust both vertically and horizontally at the same time with measuring units in any position.



## SELECT MACHINE IMAGE

Choose from different 3D machines to portray your machinery on either side of coupling.



## SELECT COUPLING TYPE

Choose measurement method depending on coupling type: short flex or spacer shaft.



## ADJUSTMENT GUIDE

The adjustment guide helps you decide optimum adjustment by simulating shimming and move. For Horizontal and Machine train program.



## BUILT-IN HELP

The app includes a searchable *Users Manual* which opens the relevant chapter depending where in the process you are. This makes it quick and easy to find the answers to your questions.

# MORE POSSIBILITIES

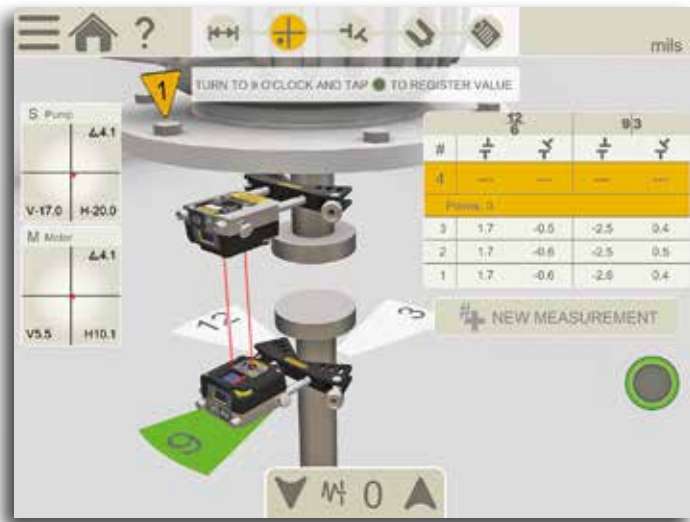

## VERTICAL/FLANGE MOUNTED MACHINES



For measurement and alignment of vertically and flange mounted machines.

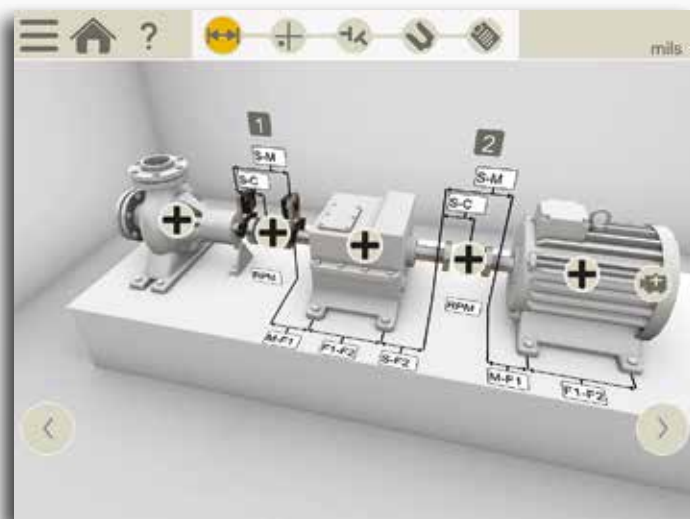

## MACHINE TRAIN



Build your own machine train with as many machines as you need. You can pick the reference machine manually, or let the program choose one that will minimize the need for adjustments.

- The easiest and most intuitive machine train interface available.
- See the complete picture of the machine train alignment to quickly determine corrections.
- Instantaneous live movement of your machines during corrections.

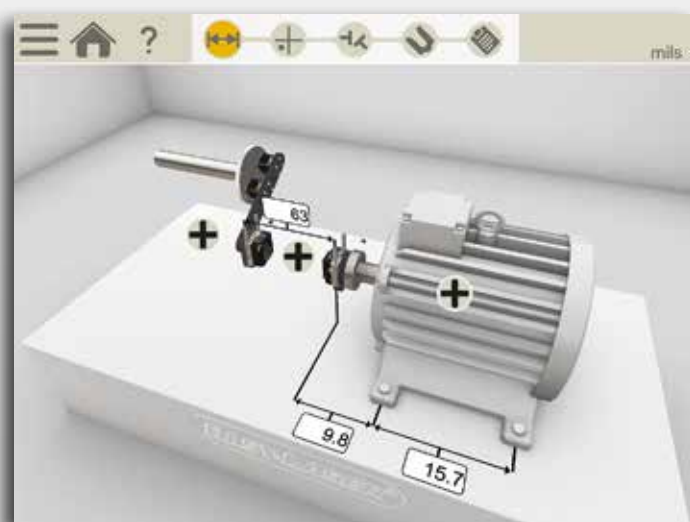

## CARDAN/OFFSET MOUNTED MACHINES



For alignment of cardan/offset mounted machinery. (Requires additional Cardan bracket Kit.)



Cardan bracket Kit

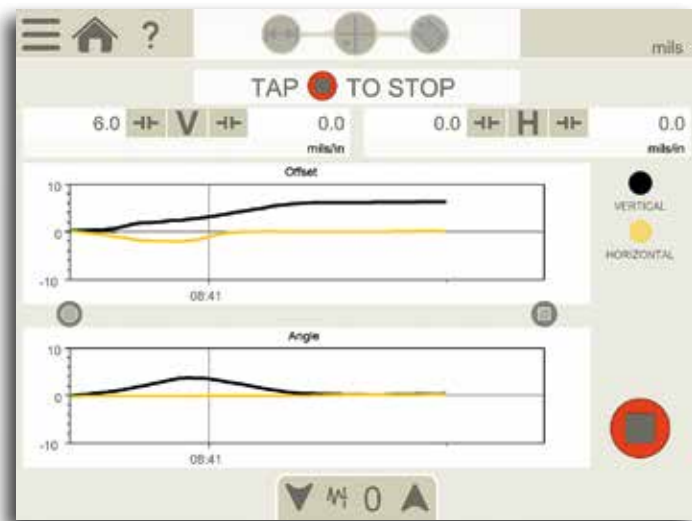

### EASYTREND



With EasyTrend you can keep track of machine movement over time.

For example you can check for thermal expansion and pipe strain issues. Requires optional DM-brackets (pictured).

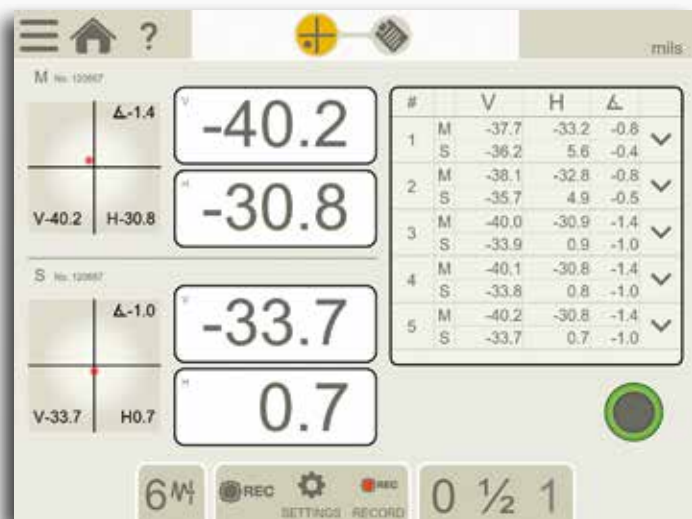
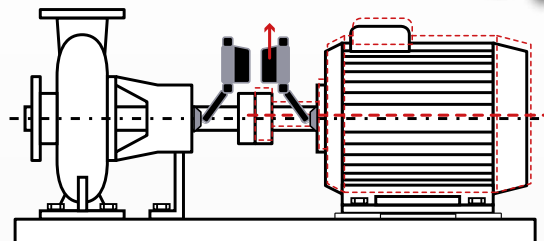

### VALUES – DIGITAL DIAL INDICATOR



With the Values program you measure as with dial gauges, but with laser precision and the capability to document the measurement result. It can also be used to "manually"

calculate straightness, flatness and dynamic movements of machine components. Automatic recording possible (set the interval and duration). XT770 records Vertical and Horizontal coordinates simultaneously. You can make individual notes for each measurement point.

### CHECK BEARING CLEARANCE



With the Values program you can check bearing clearance or shaft load.



### TWIST MEASUREMENT OF MACHINE BASE



The twist measurement program allows you to check the flatness or twist of the machine foundation using only the measuring units in the system.

# SYSTEM PARTS



## XT11 DISPLAY UNIT

Rugged, robust, with wear resistant rubberized protective coating. IP66 and 67, dust-water- and shockproof. As standard a 13 MP camera for documentation is built-in, and you can also choose to add an IR camera to the XT11; shoot a thermal image before and after alignment and include in your report!

A large 8", glove-enabled touch-screen makes the information clear and the app easy to use. A small OLED display shows battery status of both measuring units and display unit. You can check battery status also when the unit is turned off.

The clever lock-screen button prevents unintentional clicks, for instance when moving around on the job.

Four fastening points for shoulder strap or customized solutions. Heavy-duty battery for very long operating times; up to 16 hours.



## GLOVE-ENABLED TOUCH SCREEN

Navigate the screen with or without work gloves.

## XT70-M/S MEASURING UNITS

The XT70 measuring units have a dot-type laser and 2-axis square PSD surfaces. A state-of-the-art OLED display shows the angle of the unit, making it easier to position it on the shaft. The diagonally positioned locking knobs securely lock the unit on the rods. Rigid aluminum housing provides maximum stability. IP66 and 67, dust- water- and shockproof. Built-in wireless technology.

## SHAFT BRACKET

The V-bracket is light yet rigid, with two rods for maximum stability in all directions. Pre-mounted chain for quick setup on the machine.



## LONG OPERATING TIMES

Heavy-duty battery for very long operating times; up to 24 hours.

## DOT-TYPE LASER TECHNOLOGY

The dot laser technology makes it possible to measure larger machines and longer spans. It also provides higher accuracy when backlash in the coupling is present. In addition, dot laser allows you to check more things when installing a machine, e.g. twist of foundation and bearing clearance. With 2 axis PSD you can read off and record values for both vertical and horizontal directions.



## DUAL LASERS, PSD, INCLINOMETERS

With electronic inclinometers in both measuring units the system knows exactly how they are positioned. This also makes it very easy to align uncoupled shafts. The so called reversed measurement method with two laser beams and two PSD makes it possible to measure very misaligned machines. This is particularly good for new installations, where the machines are not yet in the correct position. With the Dual Technology, measurement accuracy is retained even over longer distances.





# DOCUMENTATION

## SAVE!



### INTERNAL MEMORY

Save your measurement files, photos and reports to the internal memory.



### VERSATILE FILE TYPES

Both a PDF and an Excel file are generated.



### READ QR AND BAR CODES

Assign a specific code to a specific machine, then use the built-in camera of your device to open assigned file and settings.

*(Note: camera resolution requirements applicable.)*

TYPE	NAME	DATE	Edit
File	Shut_2018-02-14 14_21_08	2018-02-14	[Icon]
File	Values_2018-04-10	2018-04-10	[Icon]
File	MSD_20180410_142801	2018-04-10	[Icon]
File	Shut Alignment Water pump 3	2018-04-10	[Icon]
File	Vertical motor AB8	2018-04-14	[Icon]

## SHOW!



### CUSTOM PDF REPORT TEMPLATES

Use one of the two formats included, or design your own.



### ADD NOTES

Add additional details so they appear in the alignment report.



### SIGN REPORTS ELECTRONICALLY

Sign-on screen to verify your job. Signature is saved with the PDF file.



### ADD PHOTO

Show what you mean.



### ADD THERMAL IMAGE

See the difference after alignment.  
*(Note: Add-on to the XT11)*



## SHARE!



### SEND THE REPORTS

Share the reports via WIFI email. Possible on all platforms.



### SAVE TO USB

Save your files to USB stick and copy to other devices.



### FLIR® IR CAMERA (A)

Shoot a thermal image before and after alignment and include in your report! (Optional)

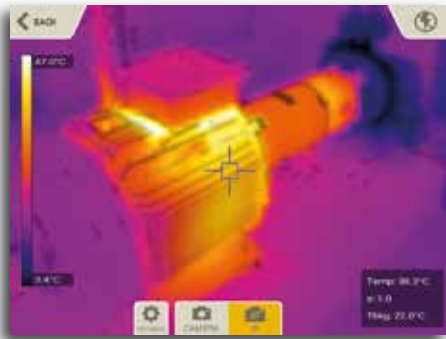

### 13 MP CAMERA (B)

Take pictures to identify your machines and include with your report. (The camera can be removed if security concerns require it.)



### LED LIGHT (C)

Light up the work area when ambient light is not enough.



### HDMI VIDEO OUTPUT

Interface with an external video display — ideal for training or to present to large groups.

# BELT ALIGNMENT TOOL



## FOR PULLEY ALIGNMENT



With the Belt alignment tool XT190 BTA you can align most types of radially mounted drives. The transmitter and detector attach magnetically to the sheave edge. A digital display unit gives the advantage of checking against belt manufacturer tolerances.

When connected to the *XT Alignment App* on your iOS or Android device\*, or the XT11, you can also read off the alignment “live” at the position on the machine where the actual alignment is made. You get adjustment values for both horizontal and vertical direction (shim value), resulting in a more accurate alignment in a shorter time. The XT190 is the perfect addition to your XT770 system, but you can also use it as a separate tool, with or without a separate display device.



SYSTEM XT190 BTA, PART NO. 12-1053

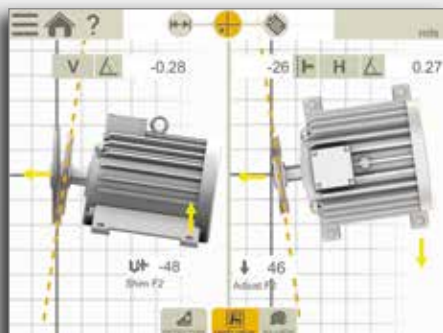

**0.15 " V**  
**0.35 °H**  
**0.45 °V**

*OLED display on detector unit. Live values.*

*Align machine in live mode, document result with PDF. (XT Alignment app Belt application.)*

*\*Conditions apply*



# VIBROMETER TOOL



## FOR QUICK VIBRATION ANALYSIS



Easy-to-use vibration analyzer that quickly diagnoses vibration level, unbalance, misalignment and looseness. The direct readout of 1x, 2x, 3x RPM, total level as well as bearing condition provide necessary information during installation and alignment.

The XT280 connects to the *XT Alignment App*, making it possible to document the result as PDF.

*Note: On left picture accessory magnet probe is used.*

**SYSTEM XT280 VIB PART NO. 12-1090**

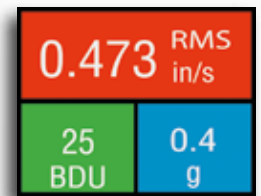

*Display on vibrometer unit. Live values.*

*Register values with notes for each point, add photo of machine, document result with PDF.*

# GEOMETRIC MEASUREMENTS



With this kit added to your XT770, you will be able to take flatness and straightness measurements with the highest reliability and precision. The kit includes the very versatile and long proven laser transmitter D22 (pictured) plus geo brackets.

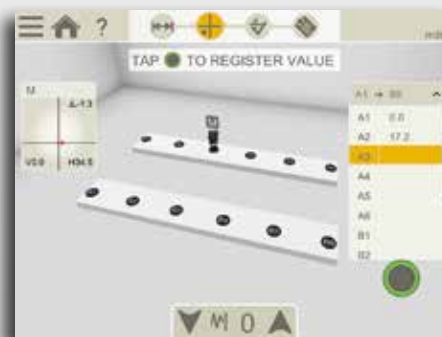

# EASY-LASER® GENERATION XT

*The age of measurement independence is here!*



**Android**



XT11



**iOS**



XT70



XT60



XT40

**NO LOCK-INS**

With Generation XT you decide if you want the rugged and user-friendly Easy-Laser® XT11 display unit to be included or not. The app also runs on your iOS or Android device\*, be it a tablet or a phone, meaning you are never locked in to a specific way of working.

**SAME INTERFACE**

Purchase multiple systems with various capabilities, train once! The training costs are minimized significantly since the app interface and basic functionality is identical for all systems.

\*Conditions apply

Easy-Laser® is manufactured by Easy-Laser AB, Alfagatan 6, SE-431 49 Möndal, Sweden  
 Tel +46 31 708 63 00, Fax +46 31 708 63 50, e-mail: info@easylaser.com, www.easylaser.com  
 © 2020 Easy-Laser AB. We reserve the right to make changes without prior notification.  
 Easy-Laser® is a registered trademark of Easy-Laser AB. Android, Google Play, and the Google Play logo are trademarks of Google Inc. Apple, the Apple logo, iPhone, and iPod touch are trademarks of Apple Inc., registered in the U.S. and other countries. App Store is a service mark of Apple Inc. Other trademarks belong to their respective owners. This product complies with: EN60825-1, 21 CFR 1040.10 and 1040.11. Contains FCC ID: Q0QBGM111, IC: 5123A-BGM111 and FCC ID: 2AFDI-ITCNFA324 IC: 9049A-ITCNFA324. Documentation ID: 05-0945 Rev3



**LUDECA**

Keep it running.

LUDECA Inc.  
 1425 N.W. 88th Avenue  
 Doral, FL 33172  
 Phone: (305) 591-8935  
 Fax: (305) 591-1537  
 info@ludeca.com  
 www.ludeca.com